



正基科技股份有限公司  
**SPECIFICATION**

---

SPEC. NO. : \_\_\_\_\_ REV : 1.2

DATE : 12. 26.2012

PRODUCT NAME : AP6210

	APPROVED	CHECKED	PREPARED	DCC ISSUE
NAME				

# AMPAK

## AP6210

WiFi 802.11b/g/n + BT4.0  
SIP Module Spec Sheet

# Revision History

Date	Revision Content	Revised By	Version
2012/09/18	- Preliminary	Bart	1.0
2012/09/25	- Modify Pin Definition	Bart	1.1
2012/12/26	- Modify Pin name 10,11	Brian	1.2

AMPAK  
Confidential

# Contents

<b>Contents .....</b>	<b>2</b>
<b>1. Introduction.....</b>	<b>3</b>
<b>2. Features.....</b>	<b>4</b>
<b>3. Deliverables .....</b>	<b>5</b>
3.1 Deliverables.....	5
3.2 Regulatory certifications .....	5
<b>4. General Specification .....</b>	<b>6</b>
4.1 General Specification.....	6
4.2 Voltages.....	6
4.2.1 Absolute Maximum Ratings.....	6
4.2.2 Recommended Operating Rating .....	6
<b>5. WiFi RF Specification .....</b>	<b>7</b>
5.1 2.4GHz RF Specification.....	7
<b>6. Bluetooth Specification.....</b>	<b>9</b>
6.1 Bluetooth Specification .....	9
<b>7. Pin Assignments.....</b>	<b>10</b>
7.1 Pin Outline.....	10
7.2 Pin Definition .....	10
<b>8. Dimensions .....</b>	<b>12</b>
8.1 Physical Dimensions.....	12
8.2 Layout Recommendation.....	13
<b>9. External clock reference .....</b>	<b>14</b>
9.1 SDIO Pin Description.....	14
<b>10. Host Interface Timing Diagram.....</b>	<b>15</b>
10.1 Power-up Sequence Timing Diagram .....	15
10.2 SDIO Default Mode Timing Diagram.....	17
10.3 SDIO High Speed Mode Timing Diagram .....	18
<b>11. Recommended Reflow Profile .....</b>	<b>19</b>
<b>12. Package Information.....</b>	<b>20</b>
12.1 Label .....	20
12.2 Dimension .....	21
12.3 MSL Level / Storage Condition .....	23

# 1. Introduction

AMPAK Technology would like to announce a low-cost and low-power consumption module which has all of the WiFi and Bluetooth functionalities. The highly integrated tiny module makes the possibilities of web browsing, VoIP, Bluetooth headsets and portable navigation applications. With seamless roaming capabilities and advanced security, also could interact with different vendors' 802.11b/g/n Access Points in the wireless LAN.

The module complies with IEEE 802.11 b/g/n standard and it could achieve up to a speed of 72.2Mbps with single stream in 802.11n draft, 54Mbps as specified in 802.11g, or 11Mbps for 802.11b to connect to the wireless LAN. The integrated module provides SDIO interface for WiFi, UART / PCM for Bluetooth.

This compact module is a total solution for a combination of WiFi + BT technologies. The module is specifically developed for Tablet, Smart phones and Portable devices.

## 2. Features

- 802.11b/g/n single-band radio
- Bluetooth V4.0 + EDR with integrated Class 1.5 PA Concurrent Bluetooth and WLAN operation
- Simultaneous BT / WLAN receive with single antenna
- WLAN host interface options:
  - SDIO v2.0 — up to 50 MHz clock rate
- BT host digital interface:
  - UART (up to 4 Mbps)
- IEEE Co-existence technologies are integrated die solution

A simplified block diagram of the module is depicted in the figure below.

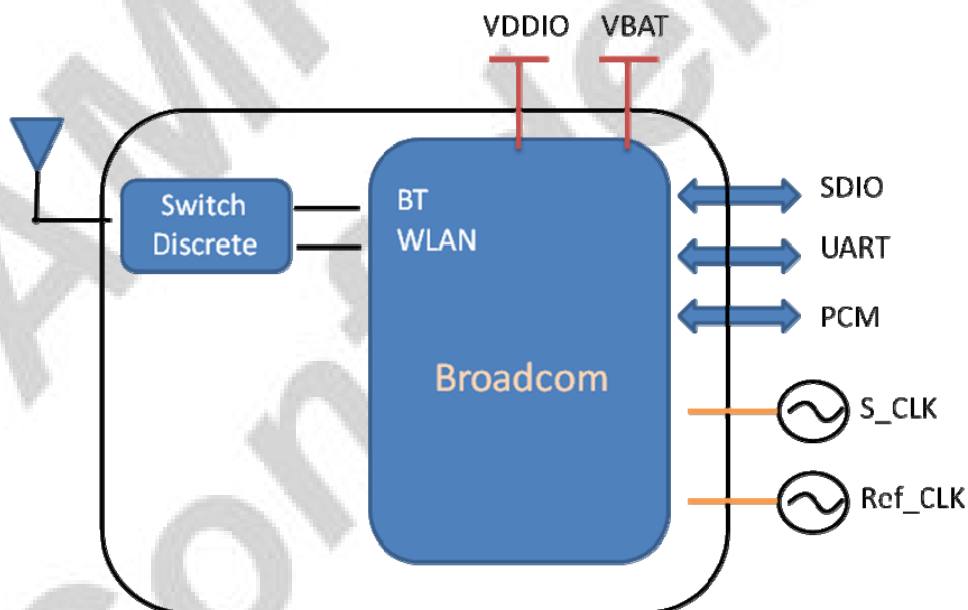

## 3. Deliverables

### 3.1 Deliverables

The following products and software will be part of the product.

- Module with packaging
- Evaluation Kits
- Software utility for integration, performance test.
- Product Datasheet.
- Agency certified pre-tested report with the adapter board.

### 3.2 Regulatory certifications

The product delivery is a pre-tested module, without the module level certification. For module approval, the platform's antennas are required for the certification.

## 4. General Specification

### 4.1 General Specification

Model Name	AP6210
Product Description	Support WiFi/Bluetooth functionalities
Dimension	L x W x H: 12.0 x 12.0 x 1.5 (typical) mm
WiFi Interface	SDIO V2.0
BT Interface	UART/ PCM
Operating temperature	-30°C to 85°C
Storage temperature	-40°C to 85°C
Humidity	Operating Humidity 10% to 95% Non-Condensing

### 4.2 Voltages

#### 4.2.1 Absolute Maximum Ratings

Symbol	Description	Min.	Max.	Unit
VBAT	Input supply Voltage	-0.5	5.5	V
VDDIO	Digital/Bluetooth/SDIO/SPI I/O Voltage	-0.5	3.6	V

#### 4.2.2 Recommended Operating Rating

The module requires two power supplies: VBAT and VDDIO

	Min.	Typ.	Max.	Unit
Operating Temperature	-30	25	85	deg.C
VBAT	3.0	3.6	4.8	V
VDDIO	1.71	3.3	3.6	V



## 5. WiFi RF Specification

### 5.1 2.4GHz RF Specification

Conditions : VBAT=3.6V ; VDDIO =3.3V ; Temp:25°C

Feature	Description
WLAN Standard	IEEE 802.11b/g/n, WiFi compliant
Frequency Range	2.400 GHz ~ 2.497 GHz (2.4 GHz ISM Band)
Number of Channels	2.4GHz : Ch1 ~ Ch14
Modulation	802.11b : DQPSK, DBPSK, CCK 802.11 g/n : OFDM /64-QAM, 16-QAM, QPSK, BPSK
Output Power	802.11b /11Mbps : 16 dBm ± 1.5 dB @ EVM ≤ -9dB
	802.11g /54Mbps : 15 dBm ± 1.5 dB @ EVM ≤ -25dB
	802.11n /65Mbps : 14 dBm ± 1.5 dB @ EVM ≤ -28dB
Receive Sensitivity (11n,20MHz) @10% PER	- MCS=0 PER @ -85 dBm, typical
	- MCS=1 PER @ -84 dBm, typical
	- MCS=2 PER @ -82 dBm, typical
	- MCS=3 PER @ -80 dBm, typical
	- MCS=4 PER @ -77 dBm, typical
	- MCS=5 PER @ -73 dBm, typical
	- MCS=6 PER @ -71 dBm, typical
	- MCS=7 PER @ -69 dBm, typical
Receive Sensitivity (11g) @10% PER	- 6Mbps PER @ -86 dBm, typical
	- 9Mbps PER @ -85 dBm, typical
	- 12Mbps PER @ -85 dBm, typical
	- 18Mbps PER @ -83 dBm, typical
	- 24Mbps PER @ -81 dBm, typical
	- 36Mbps PER @ -78 dBm, typical
	- 48Mbps PER @ -73 dBm, typical
	- 54Mbps PER @ -72 dBm, typical
Receive Sensitivity (11b) @8% PER	- 1Mbps PER @ -90 dBm, typical
	- 2Mbps PER @ -89 dBm, typical
	- 5.5Mbps PER @ -88 dBm, typical
	- 11Mbps PER @ -85 dBm, typical
Data Rate	802.11b : 1, 2, 5.5, 11Mbps
	802.11g : 6, 9, 12, 18, 24, 36, 48, 54Mbps

Data Rate (20MHz ,Long GI,800ns)	802.11n: 6.5, 13, 19.5, 26, 39, 52, 58.5, 65Mbps
Data Rate (20MHz ,short GI,400ns)	802.11n : 7.2, 14.4, 21.7, 28.9, 43.3, 57.8, 65,72.2Mbps
Maximum Input Level	802.11b : -10 dBm
	802.11g/n : -20 dBm
Antenna Reference	Small antennas with 0~2 dBi peak gain

AMPAK  
 Confidential

## 6. Bluetooth Specification

### 6.1 Bluetooth Specification

Conditions : VBAT=3.6V ; VDDIO=3.3V ; Temp:25°C

Feature	Description		
<b>General Specification</b>			
Bluetooth Standard	Bluetooth V4.0 of 1, 2 and 3 Mbps.		
Host Interface	UART		
Antenna Reference	Small antennas with 0~2 dBi peak gain		
Frequency Band	2.400 GHz ~ 2483.5 GHz		
Number of Channels	79 channels		
Modulation	FHSS, GFSK, DPSK, DQPSK		
<b>RF Specification</b>			
	<b>Min.</b>	<b>Typical.</b>	<b>Max.</b>
Output Power (Class 1.5)		10dBm	
Sensitivity @ BER=0.1% for GFSK (1Mbps)		-86 dBm	
Sensitivity @ BER=0.01% for $\pi/4$ -DQPSK (2Mbps)		-86 dBm	
Sensitivity @ BER=0.01% for 8DPSK (3Mbps)		-80 dBm	
Maximum Input Level	GFSK (1Mbps):-20dBm		
	$\pi/4$ -DQPSK (2Mbps) :-20dBm		
	8DPSK (3Mbps) :-20dBm		

# 7. Pin Assignments

## 7.1 Pin Outline

< TOP VIEW >

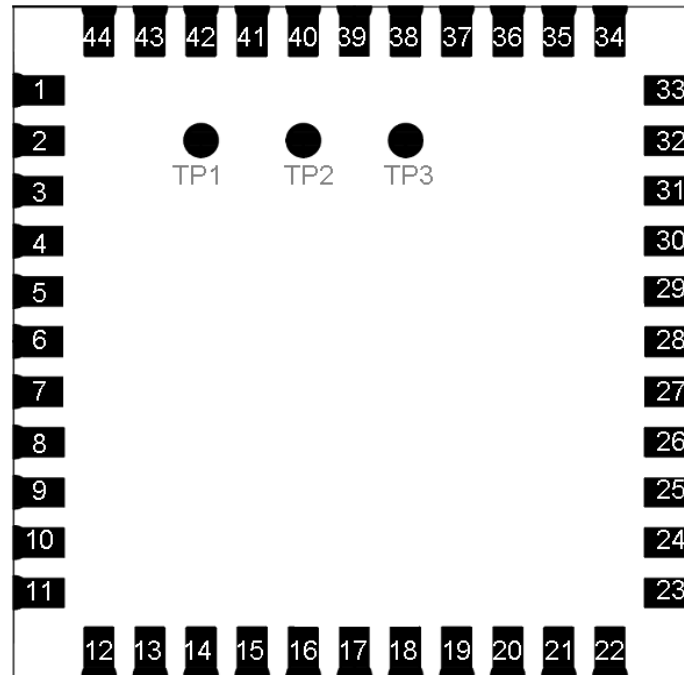

## 7.2 Pin Definition

NO	Name	Type	Description
1	GND	—	Ground connections
2	WL_BT_ANT	I/O	RF I/O port
3	GND	—	Ground connections
4	NC	—	Floating (Don't connected to ground)
5	NC	—	Floating (Don't connected to ground)
6	BT_WAKE	I	HOST wake-up Bluetooth device
7	BT_HOST_WAKE	O	Bluetooth device to wake-up HOST
8	NC	—	Floating (Don't connected to ground)
9	VBAT	P	Main power voltage source input
10	NC	—	Floating (Don't connected to ground)
11	NC	—	Floating (Don't connected to ground)
12	WL_REG_ON	I	Internal regulators power enable/disable
13	WL_HOST_WAKE	O	WLAN to wake-up HOST
14	SDIO_DATA_2	I/O	SDIO data line 2

15	SDIO_DATA_3	I/O	SDIO data line 3
16	SDIO_DATA_CMD	I/O	SDIO command line
17	SDIO_DATA_CLK	I/O	SDIO CLK line
18	SDIO_DATA_0	I/O	SDIO data line 0
19	SDIO_DATA_1	I/O	SDIO data line 1
20	GND	—	Ground connections
21	VIN_LDO_OUT	P	Internal Buck voltage generation pin
22	VDDIO	P	I/O Voltage supply input
23	VIN_LDO	P	Internal Buck voltage generation pin
24	LPO	I	External Low Power Clock input (32.768KHz)
25	PCM_OUT	I/O	PCM Data output
26	PCM_CLK	I/O	PCM Clock
27	PCM_IN	I/O	PCM data input
28	PCM_SYNC	I/O	PCM sync signal
29	WL_VDD_TCXO	P	1.7V to 3.3V supply for the TCXO driver
30	TCXO_IN	I	Reference clock input
31	GND	—	Ground connections
32	NC	—	Floating (Don't connected to ground)
33	GND	—	Ground connections
34	BT_RST_N	I	Low asserting reset for Bluetooth core
35	NC	—	Floating (Don't connected to ground)
36	GND	—	Ground connections
37	BT_XTAL_IN	I	Crystal input for BT
38	BT_XTAL_OUT	O	Crystal output for BT
39	NC	—	Floating (Don't connected to ground)
40	NC	—	Floating (Don't connected to ground)
41	UART_RTS_N	O	Bluetooth UART interface
42	UART_TXD	O	Bluetooth UART interface
43	UART_RXD	I	Bluetooth UART interface
44	UART_CTS_N	I	Bluetooth UART interface
45	TP1 (NC)	—	Floating (Don't connected to ground)
46	TP2 (NC)	—	Floating (Don't connected to ground)
47	TP3 (NC)	—	Floating (Don't connected to ground)

# 8. Dimensions

## 8.1 Physical Dimensions

(Unit: mm)

< TOP VIEW >

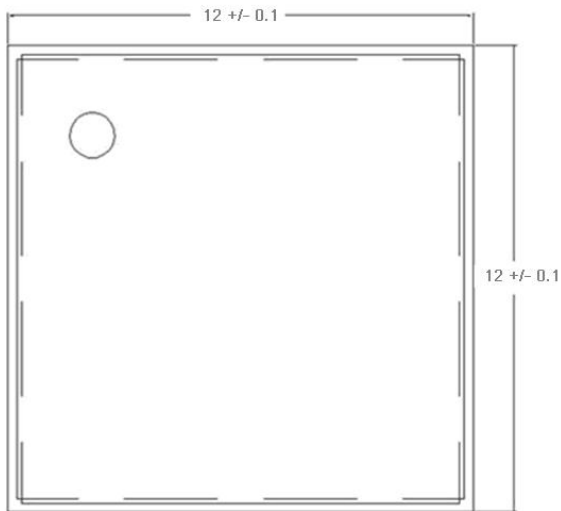

< Side View >

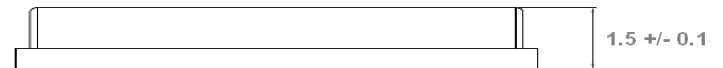

< TOP VIEW >

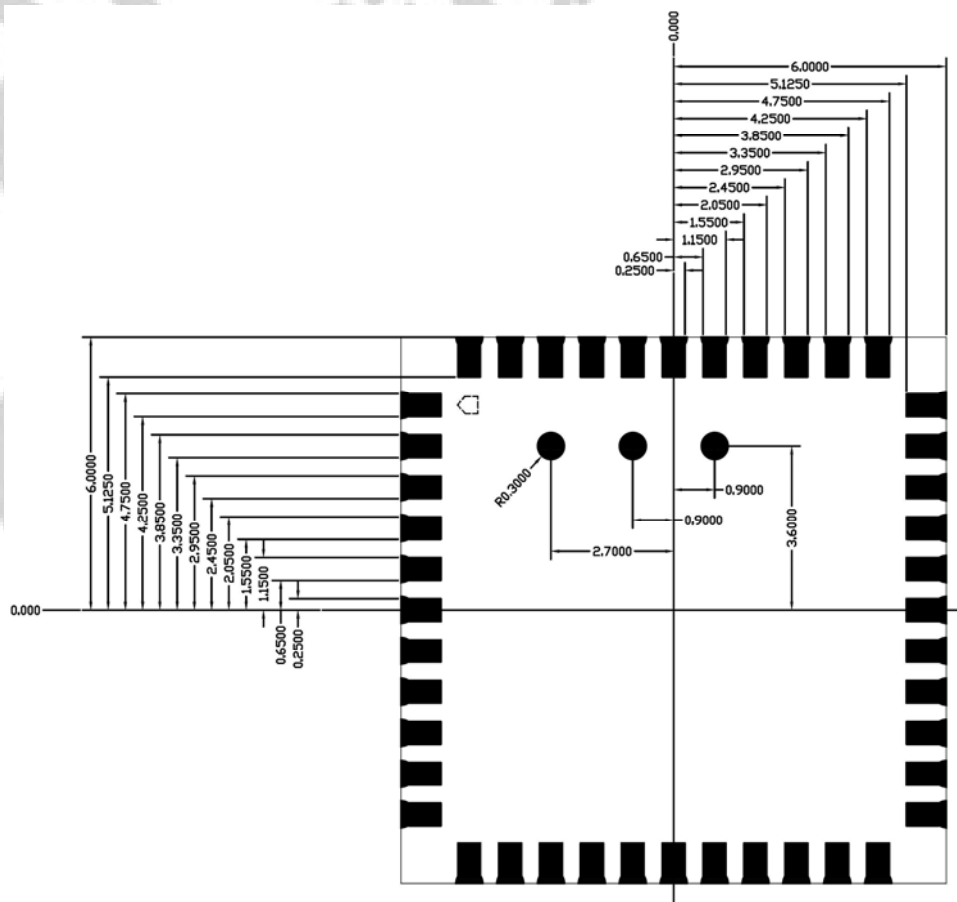

## 8.2 Layout Recommendation

(Unit: mm)

< TOP VIEW >

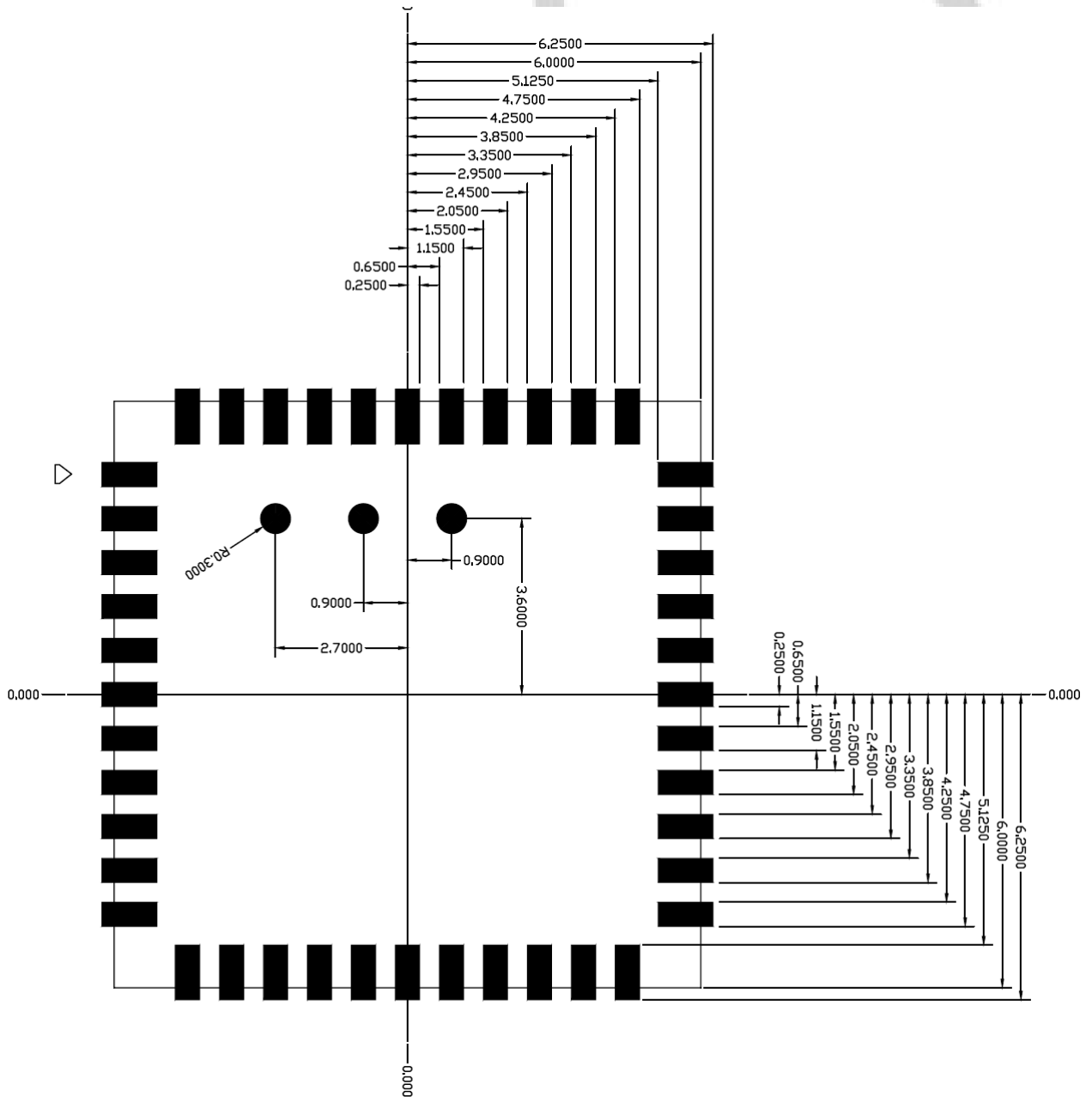

## 9. External clock reference

External LPO signal characteristics

Parameter	Specification	Units
Nominal input frequency	32.768	kHz
Frequency accuracy	±30	ppm
Duty cycle	30 - 70	%
Input signal amplitude	1600 to 3300	mV, p-p
Signal type	Square-wave or sine-wave	-
Input impedance	>100k	Ω
	<5	pF
Clock jitter (integrated over 300Hz – 15KHz)	<1	Hz
Output high voltage	0.7V <sub>io</sub> - V <sub>io</sub>	V

External Ref\_CLK signal characteristics

No.	Item	Symb.	Electrical Specification				Remark
			Min.	Type	Max.	Units	
1	Nominal Frequency	F0	26.00000			MHz	
2	Mode of Vibration		Fundamental				
3	Frequency Tolerance	ΔF/F0	-10	-	10	ppm	at 25°C±3°C
4	Operating Temperature Range	T <sub>OPR</sub>	-30	-	85	°C	
5	Frequency Stability	TC	-10	-	10	ppm	
6	Storage Temperature	T <sub>STG</sub>	-55	-	125	°C	
7	Load capacitance	CL	-	16		pF	
8	Equivalent Series Resistance	ESR	-	-	50	Ω	
9	Drive Level	DL	-	100	200	μW	
10	Insulation Resistance	IR	500	-	-	MΩ	At 100V <sub>DC</sub>
11	Shunt Capacitance	C0	-	-	3	pF	
12	Aging Per Year	Fa	-2	-	2	ppm	First Year

### 9.1 SDIO Pin Description

The module supports SDIO version 2.0 for 4-bit modes. It has the ability to stop the SDIO clock and map the interrupt signal into a GPIO pin. This 'out-of-band' interrupt signal notifies the host when the WLAN device wants to turn on the SDIO interface. The ability to force the control of the gated clocks from within the WLAN chip is also provided.



- ❖ Function 0 Standard SDIO function (Max BlockSize / ByteCount = 32B)
- ❖ Function 1 Backplane Function to access the internal System On Chip (SOC) address space (Max BlockSize / ByteCount = 64B)
- ❖ Function 2 WLAN Function for efficient WLAN packet transfer through DMA (Max BlockSize/ByteCount=512B)

SDIO Pin Description

SDIO 4-Bit Mode	
DATA0	Data Line 0
DATA1	Data Line 1 or Interrupt
DATA2	Data Line 2 or Read Wait
DATA3	Data Line 3
CLK	Clock
CMD	Command Line

## 10. Host Interface Timing Diagram

### 10.1 Power-up Sequence Timing Diagram

The module has two signals that allow the host to control power consumption by enabling or disabling the Bluetooth, WLAN and internal regulator blocks. These signals are described below.

Additionally, diagrams are provided to indicate proper sequencing of the signals for various operating states. The timing values indicated are minimum required values; longer delays are also acceptable.

- ※ WL\_REG\_ON: Used by the PMU to power up the WLAN section. It is input to control the internal WLAN regulators. When this pin is high, the regulators are enabled and the WLAN section is out of reset. When this pin is low the WLAN section is in reset.
- ※ BT\_RST\_N: Used by the PMU to power up the internal Bluetooth regulators. If the BT\_RST\_N pins are low, the regulators are disabled.

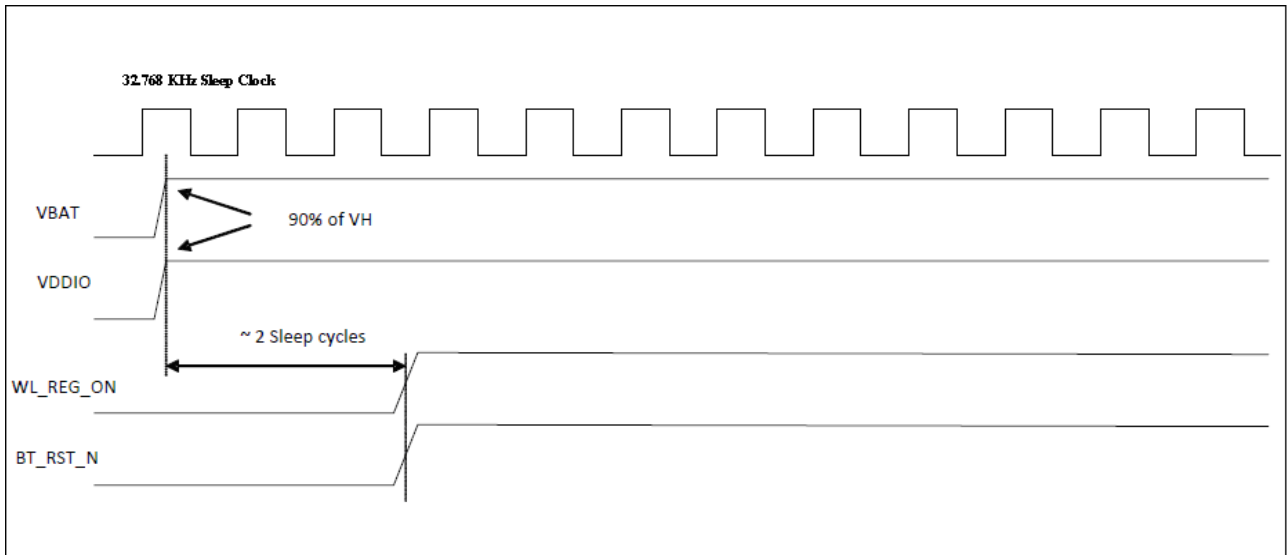

WLAN=ON, Bluetooth =ON

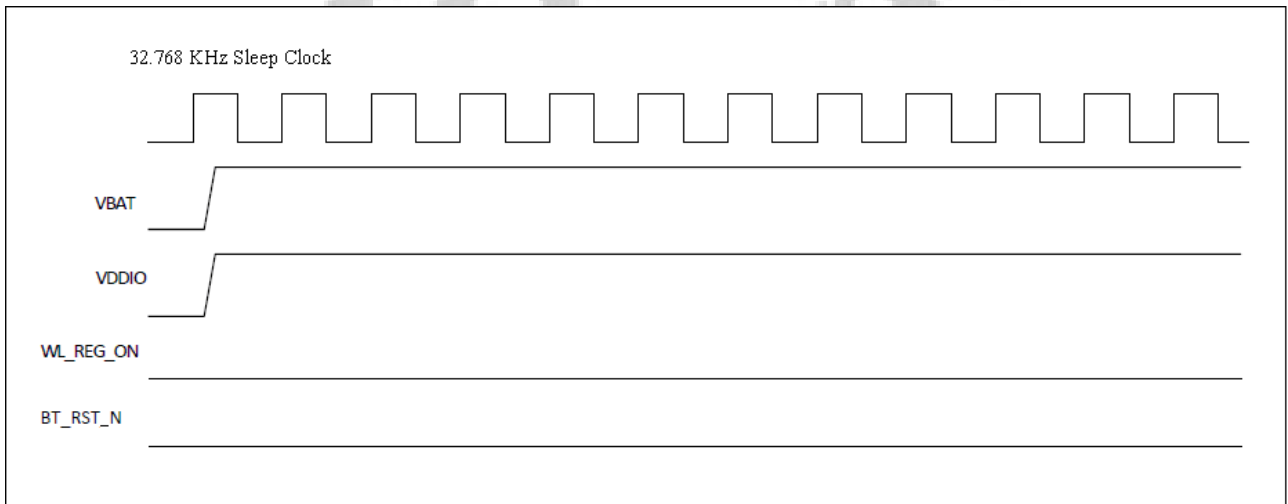

WLAN=OFF, Bluetooth =OFF

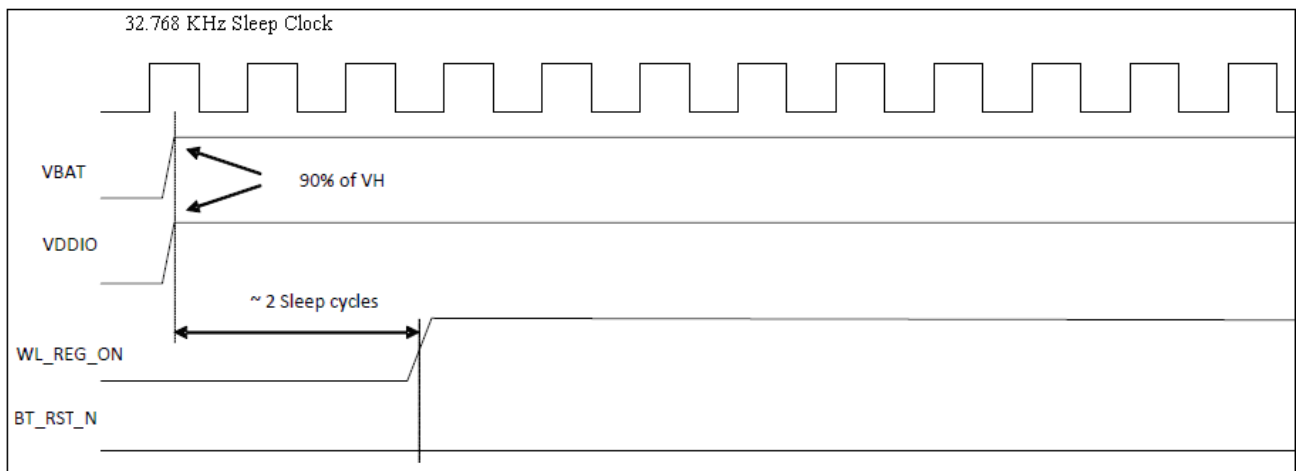

WLAN=ON, Bluetooth =OFF

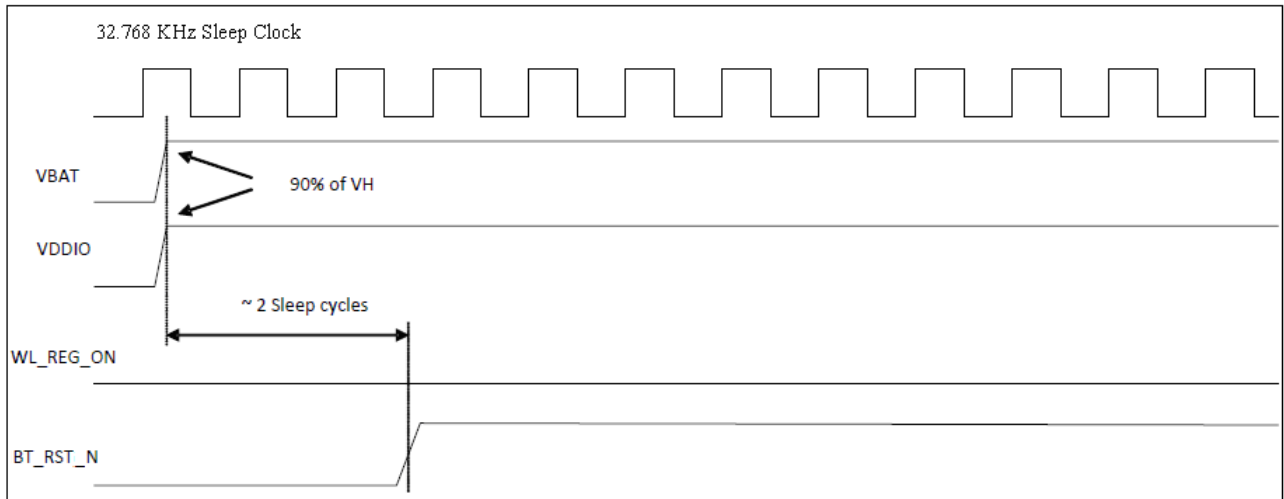

WLAN=OFF, Bluetooth=ON

### 10.2 SDIO Default Mode Timing Diagram

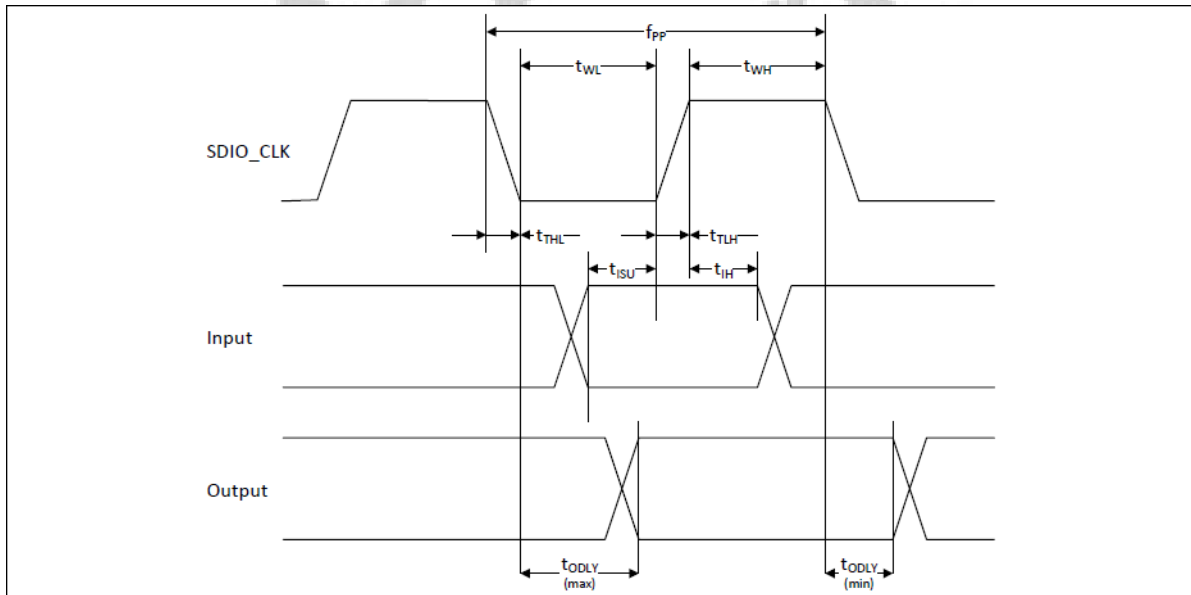

Parameter	Symbol	Minimum	Typical	Maximum	Unit
<b>SDIO CLK (All values are referred to minimum V<sub>IH</sub> and maximum V<sub>IL</sub><sup>b</sup>)</b>					
Frequency-Data Transfer mode	f <sub>PP</sub>	0	-	25	MHz
Frequency-Identification mode	f <sub>OD</sub>	0	-	400	kHz
Clock low time	t <sub>WL</sub>	10	-	-	ns
Clock high time	t <sub>WH</sub>	10	-	-	ns
Clock rise time	t <sub>TLH</sub>	-	-	10	ns
Clock low time	t <sub>TLL</sub>	-	-	10	ns
<b>Inputs: CMD, DAT (referenced to CLK)</b>					
Input setup time	t <sub>ISU</sub>	5	-	-	ns
Input hold time	t <sub>IH</sub>	5	-	-	ns
<b>Outputs: CMD, DAT (referenced to CLK)</b>					
Output delay time - Data Transfer mode	t <sub>ODLY</sub>	0	-	14	ns
Output delay time - Identification mode	t <sub>ODLY</sub>	0	-	50	ns

a. Timing is based on CL ≤ 40pF load on CMD and Data.  
 b. min(V<sub>IH</sub>) = 0.7 × V<sub>DDIO</sub> and max(V<sub>IL</sub>) = 0.2 × V<sub>DDIO</sub>.

### 10.3 SDIO High Speed Mode Timing Diagram

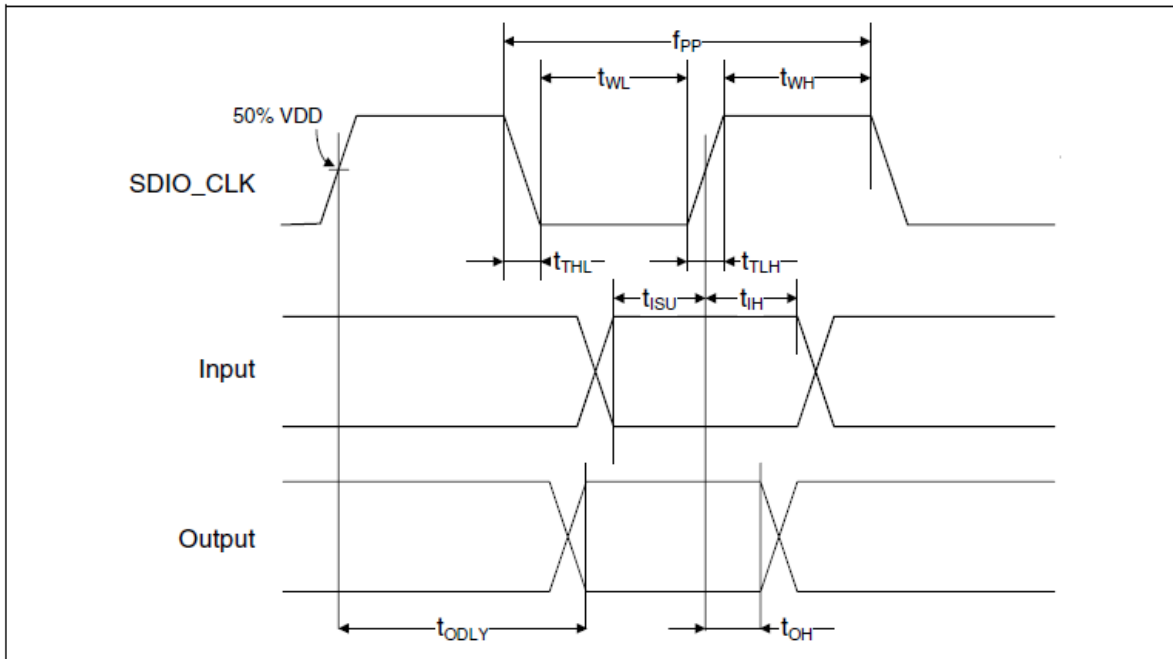

Parameter	Symbol	Minimum	Typical	Maximum	Unit
<b>SDIO CLK (All values are referred to minimum VIH and maximum VIL<sup>b</sup>)</b>					
Frequency-Data Transfer mode	f <sub>PP</sub>	0	-	50	MHz
Frequency-Identification mode	f <sub>OD</sub>	0	-	400	kHz
Clock low time	t <sub>WL</sub>	7	-	-	ns
Clock high time	t <sub>WH</sub>	7	-	-	ns
Clock rise time	t <sub>TLH</sub>	-	-	3	ns
Clock low time	t <sub>THL</sub>	-	-	3	ns
<b>Inputs: CMD, DAT (referenced to CLK)</b>					
Input setup time	t <sub>ISU</sub>	6	-	-	ns
Input hold time	t <sub>IH</sub>	2	-	-	ns
<b>Outputs: CMD, DAT (referenced to CLK)</b>					
Output delay time - Data Transfer mode	t <sub>ODLY</sub>	-	-	14	ns
Output hold time	t <sub>OH</sub>	2.5	-	-	ns
Total system capacitance (each line)	CL	-	-	40	pF

a. Timing is based on CL ≤ 40pF load on CMD and Data.

b. min(V<sub>Ih</sub>) = 0.7 x V<sub>DDIO</sub> and max(V<sub>Il</sub>) = 0.2 x V<sub>DDIO</sub>.

# 11. Recommended Reflow Profile

Referred to IPC/JEDEC standard.

Peak Temperature : <250°C

Number of Times : ≤2 times

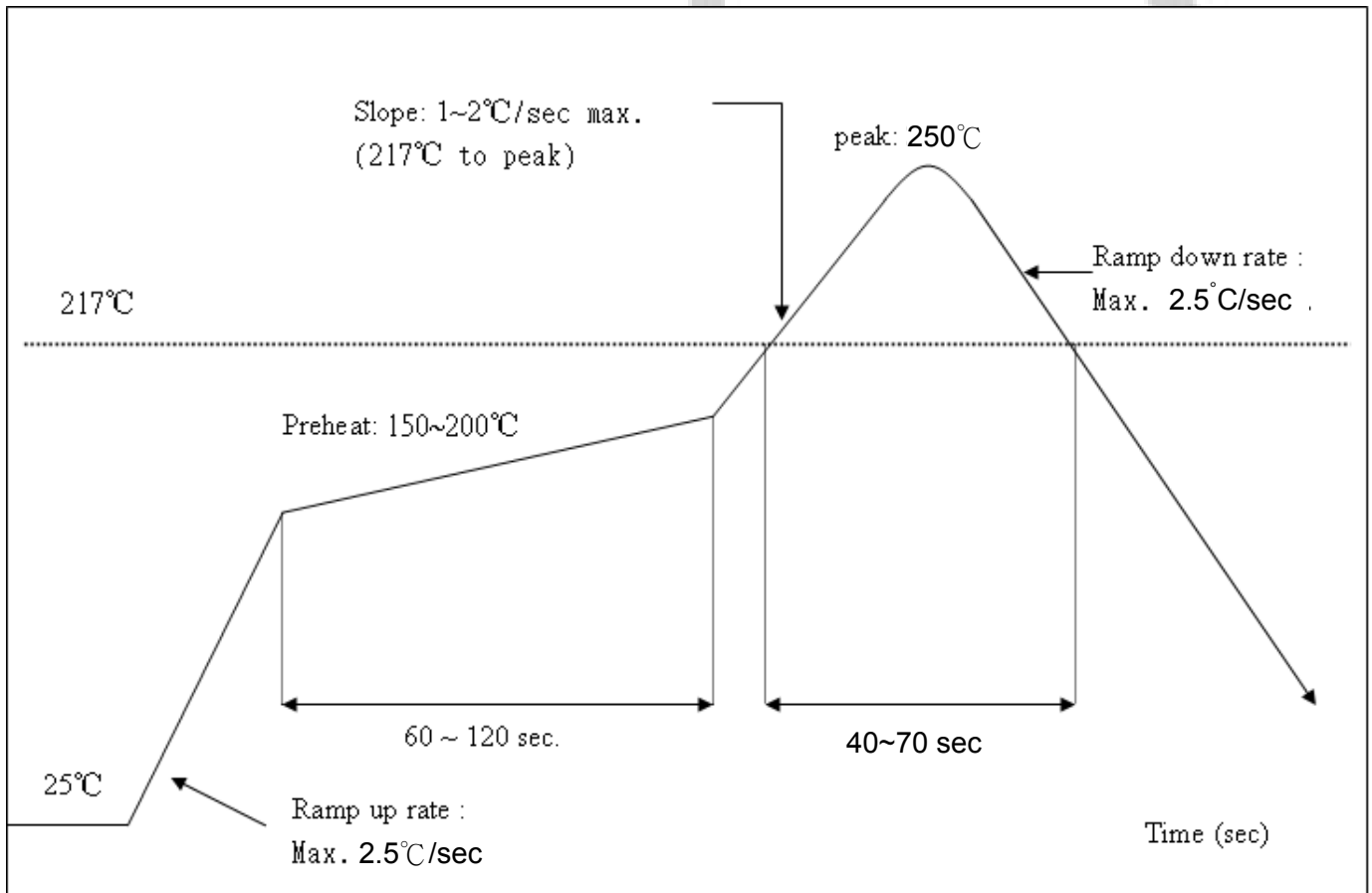

# 12. Package Information

## 12.1 Label

Label A → Anti-static and humidity notice



Label B → MSL caution / Storage Condition

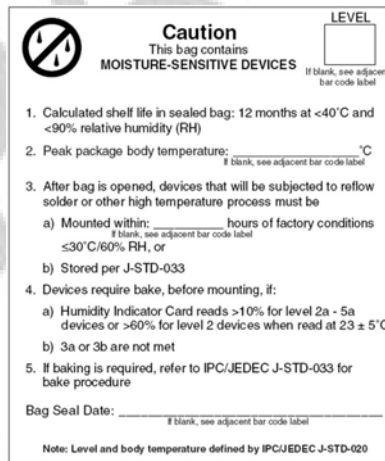

Label C → Inner box label .



Label D → Carton box label .



### 12.2 Dimension

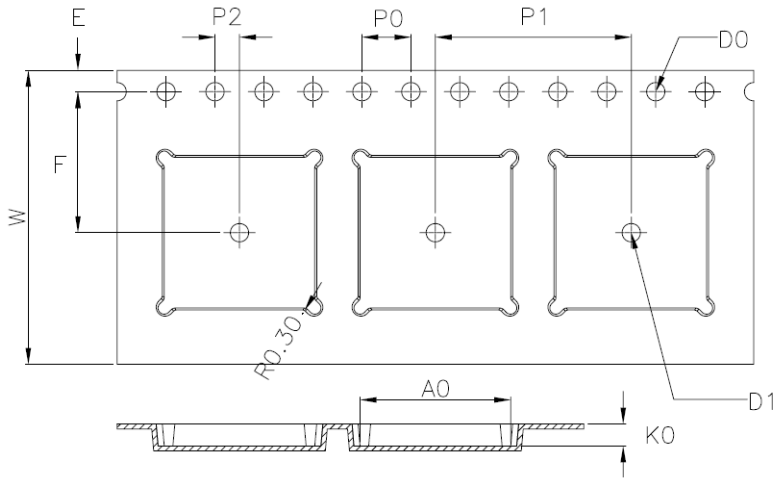

W	24.00±0.30
A0	12.30±0.10
B0	12.30±0.10
K0	1.80±0.10
E	1.75±0.10
F	11.50±0.10
P0	4.00±0.10
P1	16.00±0.10
P2	2.00±0.10
D0	1.50 <sup>+0.10</sup> / <sub>-0.00</sub>
D1	∅1.50MIN

1. 10 sprocket hole pitch cumulative tolerance ±0.20.
2. Carrier camber is within 1 mm in 250 mm.
3. Material : Black Conductive Polystyrene Alloy.
4. All dimensions meet EIA-481-D requirements.
5. Thickness : 0.30±0.05mm.
6. Packing length per 22" reel : 98.5 Meters.(1:3)
7. Component load per 13" reel : 1500 pcs.

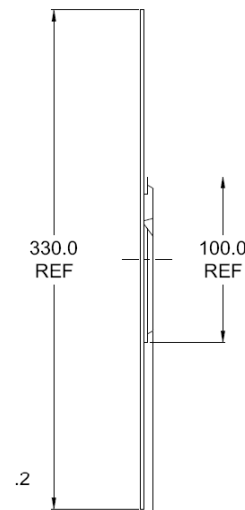
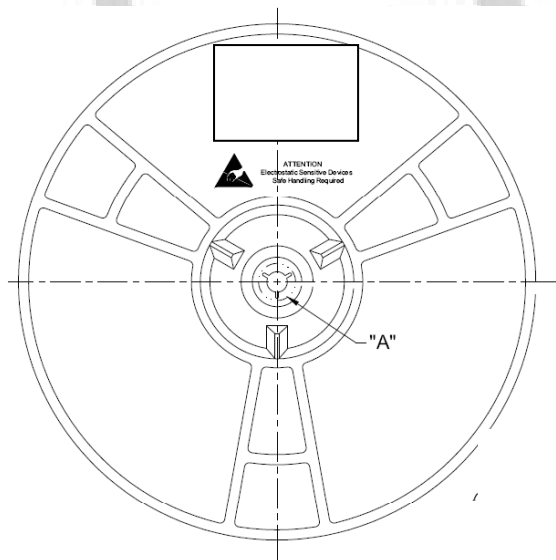

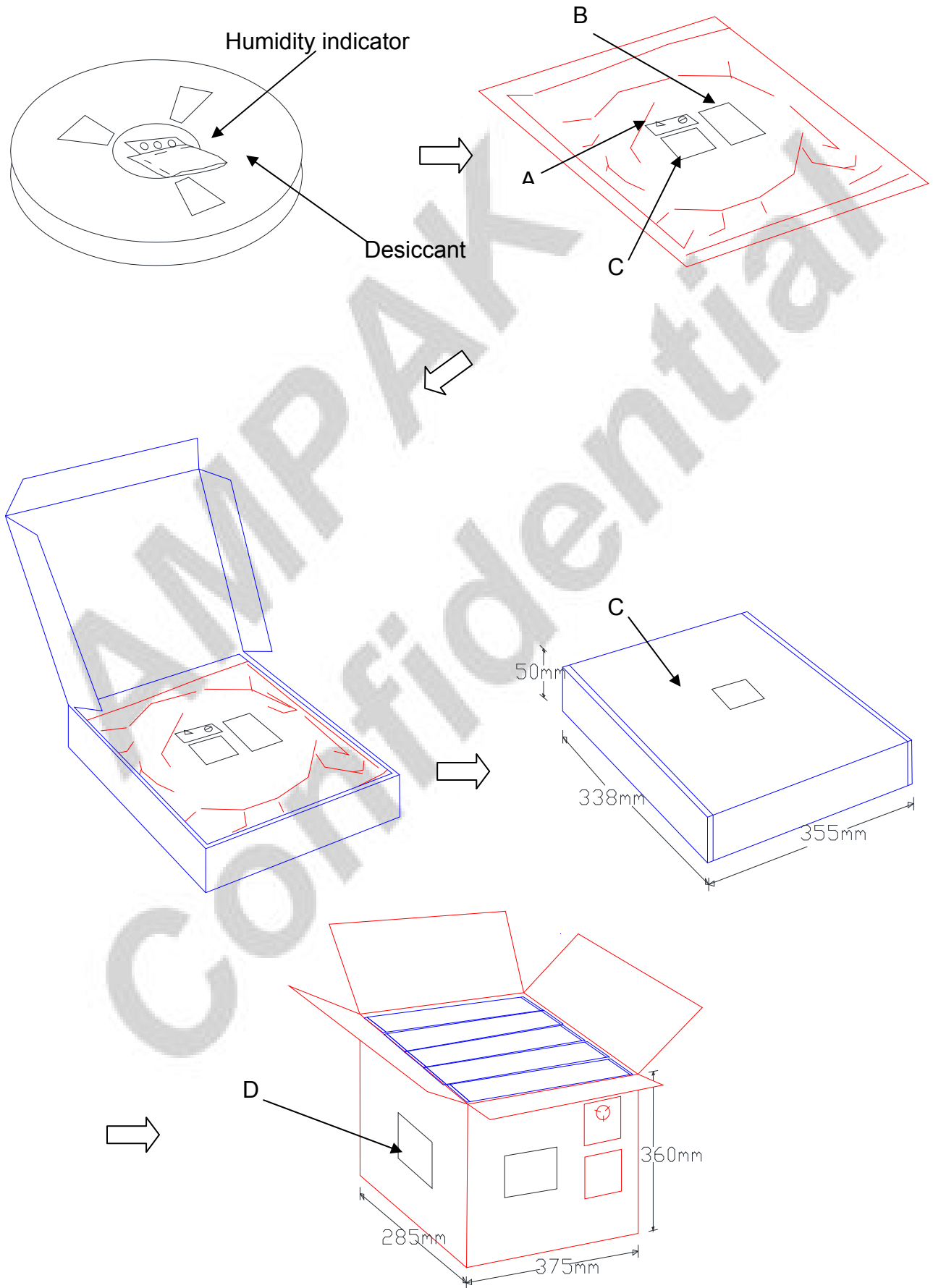



### 12.3 MSL Level / Storage Condition

	<p><b>Caution</b> This bag contains <b>MOISTURE-SENSITIVE DEVICES</b></p> <p>Do not open except under controlled conditions</p> <p>1. Calculated shelf life in sealed bag: 12 months at &lt; 40°C and &lt; 90% relative humidity(RH)</p> <p>2. Peak package body temperature:      225°C   240°C   250°C   260°C  <input type="checkbox"/>            <input type="checkbox"/>            <input checked="" type="checkbox"/>            <input type="checkbox"/></p> <p>3. After bag is opened, devices that will be subjected to reflow solder or other high temperature process must  a) Mounted within: 48 hours of factory conditions            &lt;30°C/60% RH, OR  b) Stored at &lt;10% RH</p> <p>4. Devices require bake, before mounting, if:  a) Humidity Indicator Card is &gt;10% when read at 23±5°C  b) 3a or 3b not met</p> <p>5. If baking is required, devices may be baked for 24 hours at 125±5°C</p> <p>Note : If device containers cannot be subjected to high temperature or shorter bake times are desired, reference IPC/JEDEC J-STD-033 for bake procedure</p> <p>Bag Seal Date: _____ <b>See-SEAL DATE LABEL</b> _____</p> <p>Note: Level and body temperature defined by IPC/JEDEC J-STD-020</p>	<p>LEVEL</p> <div style="border: 1px solid black; padding: 10px; width: 60px; margin: 0 auto;"> <p style="font-size: 24px; margin: 0;">4</p> </div>
---	--	---

**※NOTE : Accumulated baking time should not exceed 96hrs**